

X-BIM CAD Browser Short Manual TROX components, X-CUBE air handling units and X-FANS

Version 1.09.00 (24.08.2021)

Agenda

- Introduction and overview
 - What is the X-BIM CAD Browser.....[S.3 – S.5]

- Installation and Update.....[S.6 – S.11]

- Use of the X-BIM CAD Browsers
 - Basic functions and strategies of use.....[S.12 – S.16]
 - Configuring and importing TROX components.....[S.17 – S.22]
 - EPF projects as a basis for BIM data[S.23 – S.28]
 - Configure and import TROX air handling units.....[S.29 – S.41]
 - Configure and import TROX X-FANS.....[S.42 – S.49]

- Further information.....[S.50 – S.51]



Introduction and overview

Page 3 - 5



X-BIM CAD Browser...

...has been developed in order to make designing safer and easier for you. 3D modeling was used in many engineering departments even before BIM.

No expert design is possible without product data from manufacturers. X-BIM CAD Browser allows you to use specific TROX components, TROX air handling units and TROX X-FANS with your Revit or AutoCAD application. Moreover you can use the X-BIM CAD Browser very easily to create formats such as DWG, DXF, and IFC. This makes three-dimensional planning with TROX products possible with almost all model-based planning tools.

TROX data source



X-BIM CAD Browser

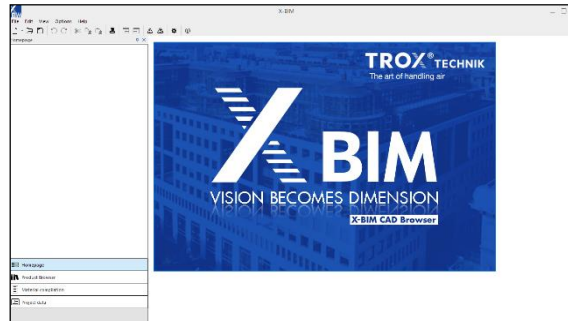
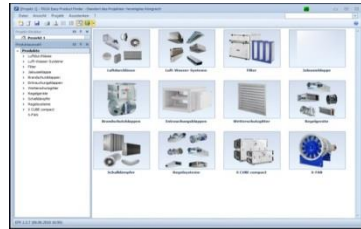

Design software

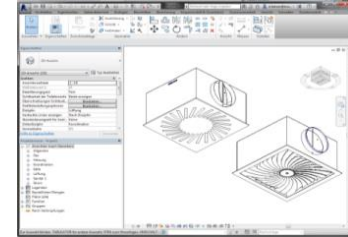
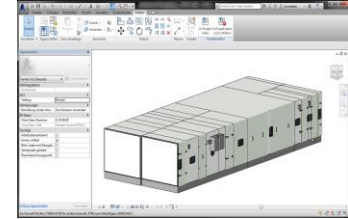



Installation and Update

Page 6 - 11

General installation and update notes

Before installing an update, the already installed X-BIM CAD Browser must be closed.

The free installation file of the X-BIM CAD Browser can be found in the [BIM section of the TROX homepage](#) as well as on the website of liNear (www.linear.eu) in the [Data sets - TROX section](#).

After installing or updating the X-BIM CAD Browser, please also restart the Revit or AutoCAD application once to ensure clean recognition and linking of the applications.

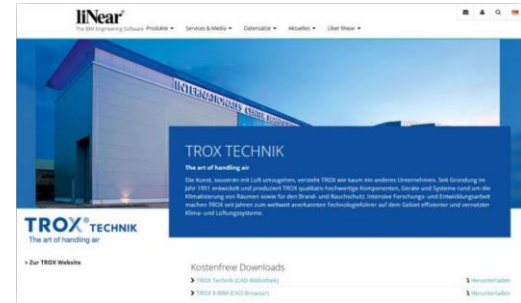

Installation and Update

First installation

Selection of the installation language

1

English

Deutsch (German)

English

list and click on Install. The chosen products will be installed successively.

X-BIM (installed)

TROX Technik CAD-Bibliothek

liNear Updater

Microsoft .NET Framework (installed)

Description

X-BIM CAD Browser

Browser for manufacturer specific drawings

- Generation of parts lists

- Output in txt-format

- Output in GAEB-format

< Back Install Quit

Update

Selection for an update

2.2

English

Choose the products from the list and click on Install. The chosen products will be installed successively.

X-BIM (Update)

TROX Technik CAD-Bibliothek (Update)

liNear Updater (installed)

Microsoft .NET Framework (installed)

Description

X-BIM CAD Browser

Browser for manufacturer specific drawings

- Generation of parts lists

- Output in txt-format

- Output in GAEB-format

< Back Install Quit

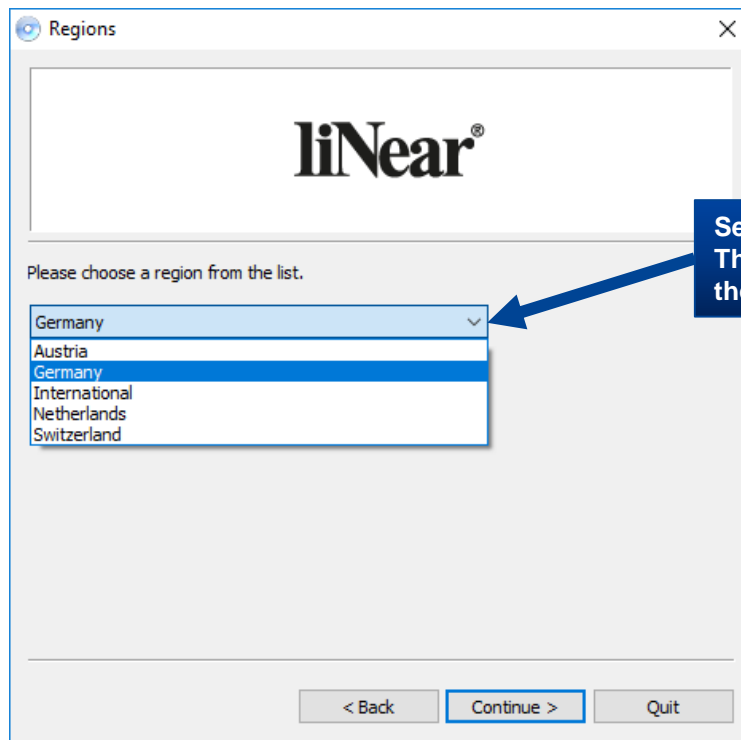

**Selection of the location.
The selection has an effect on
the availability of products.**

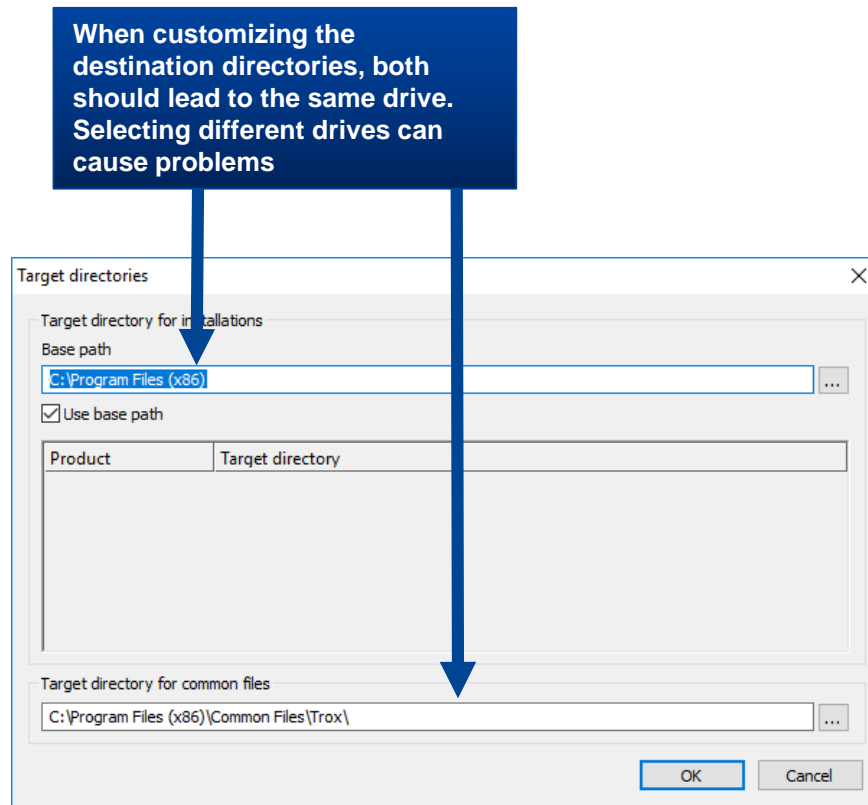
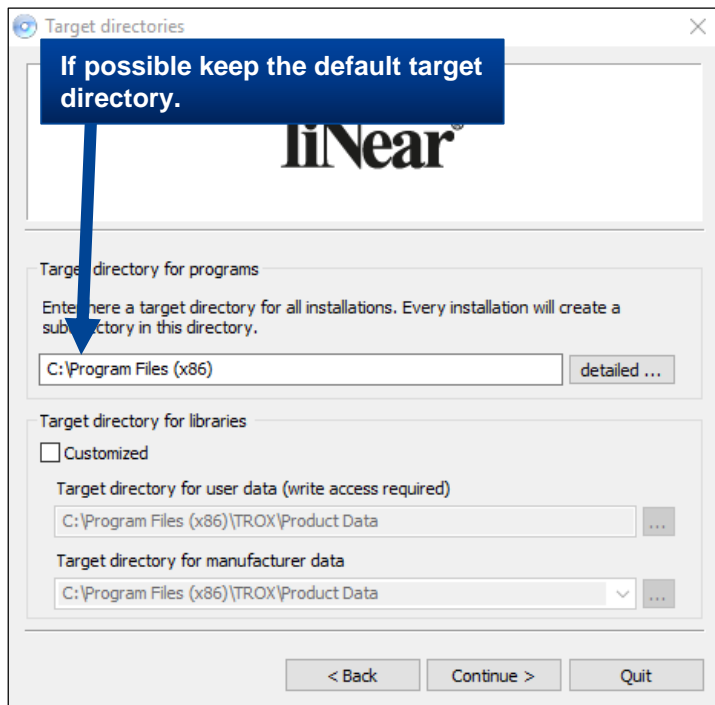

Note

- After installation, the computer should be restarted, to establish a connection between Revit / AutoCAD and the X-BIM CAD Browser.
- If a restart is not possible at that moment, at least a restart of Revit or AutoCAD must be done to enable an interchange of data between the applications.
- At the first time you start Revit / AutoCAD after installing the X-BIM CAD browser, you will be asked to allow a connection of this liNear application for Revit. You must confirm this request to be able to use the X-BIM CAD Browser together with your CAD software. If you refuse here, it is not possible to use the transfer function of BIM files from the X-BIM CAD Browser to your application.



Basic functions and strategies of use

Page 12 -16

Starting screen

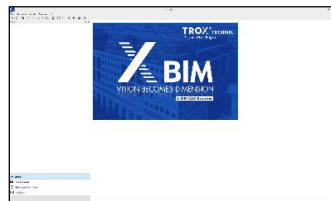

Product selection

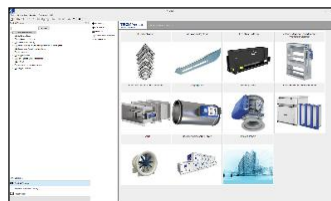

Bill of material

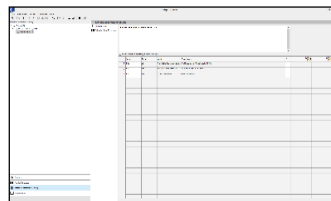

Project data

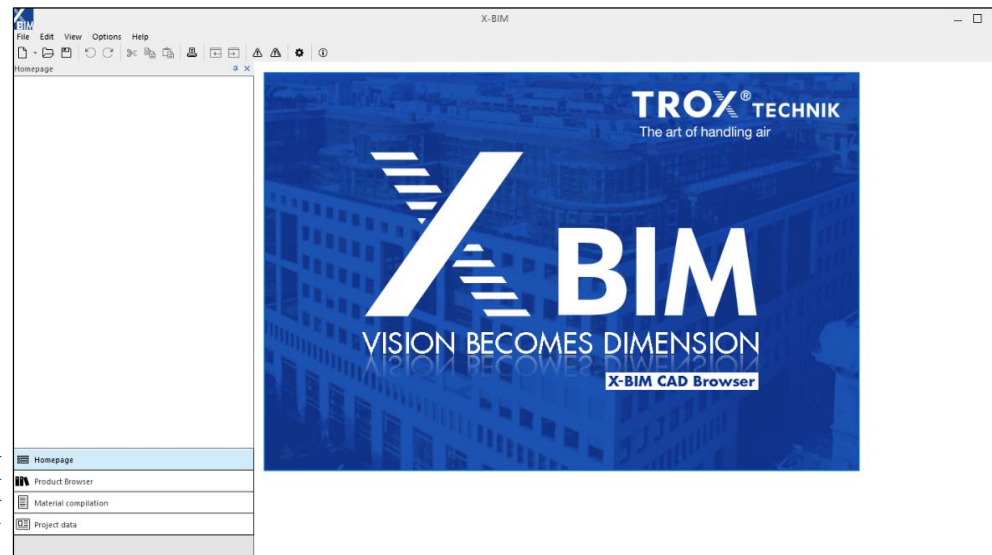
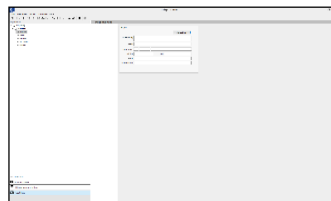

Specification text

DWG/DXF/IFC + product data sheet

Display of the specification text with the technical data for the selected variant

Interactive 3D view

Product Browser

Product

TROX[®] TECHNIK
The art of handling air

TROX Technik 07/2021 > Air terminal devices > Ceiling diffusers > Ceiling swirl diffusers > AIRNAMIC > AIRNAMIC-R-Z/400L

AIRNAMIC-R-Z/400L
AIRNAMIC-R-Z/400L
904 m³/h

3D detailed

Place Replace Replace all Parameter file

Description Documents

Ceiling swirl diffusers with square or circular diffuser face, for comfort zones with particularly dense and design. Supply air and extract air variants. Excellent aerodynamic and acoustic function due to air aerofol contours, for horizontal swirling air discharge, creating high levels of induction. For install suspended ceilings. Ready-to-install component which consists of the diffuser face and a plenum box, esp. air variants), side entry spigot, cross bar, and suspension holes or suspension lugs. The diffuser face a central screw, concealed by a decorative cap. Spigot suitable for ducts to EN 1506 or EN 13108. Sound air-regenerated noise measured according to EN ISO 5135.

SPECIAL CHARACTERISTICS

- Plastic diffuser face with overlapping, three-dimensionally profiled blades, for the most efficient
- For all types of gelling systems, and with an extended border also suitable for freely suspended in
- Diffuser face with gently sloped, flat border - only 3 mm high
- Plenum box for supply air, with an optimised equalising element that ensures a uniform airflow thro

MATERIALS AND SURFACES

- Diffuser face, spigot and damper blade made of ABS plastic, UL 94, V-0, flame retardant
- Plenum box and cross bar made of galvanised sheet steel
- Equalising element made of synthetic fibre
- Double lip seal made of rubber.

The product data sheet is available as PDF and with a link to the product page

Open 2D and 3D DWG or DXF files or copy them to the clipboard

Interactive 3D view

Product Browser

Product

TROX[®] TECHNIK
The art of handling air

TROX Technik 07/2021 > Air terminal devices > Ceiling diffusers > Ceiling swirl diffusers > AIRNAMIC > AIRNAMIC-R-Z/400L

AIRNAMIC-R-Z/400L
AIRNAMIC-R-Z/400L
904 m³/h

3D detailed

Place Replace Replace all Parameter file

Description Documents

Product information

00234228_0 .pdf

Displayed model as DWG

- 3D .dwg 3D view (dwg)
- 2Dfront .dwg 2D view front (dwg)
- 2Dback .dwg 2D view back (dwg)
- 2Dleft .dwg 2D view left (dwg)
- 2Dright .dwg 2D view right (dwg)
- 2Dtop .dwg 2D view top (dwg)
- 2Dbottom .dwg 2D view bottom (dwg)

Displayed model as DXF

- 3D .dxf 3D view (dxf)
- 2Dfront .dxf 2D view front (dxf)
- 2Dback .dxf 2D view back (dxf)
- 2Dleft .dxf 2D view left (dxf)
- 2Dright .dxf 2D view right (dxf)
- 2Dtop .dxf 2D view top (dxf)
- 2Dbottom .dxf 2D view bottom (dxf)

Selection of the display options of the product (2D/3D LOD)

Selection of the transfer to Revit or AutoCAD

Component can be placed in CAD program

Replaces an existing product (in the planning application) with the current product from the X-BIM CAD Browser.

Replaces all the same products (in the planning application) with the current product from the X-BIM CAD browser

Only the simplified geometry is transferred to Revit/AutoCAD if activated.

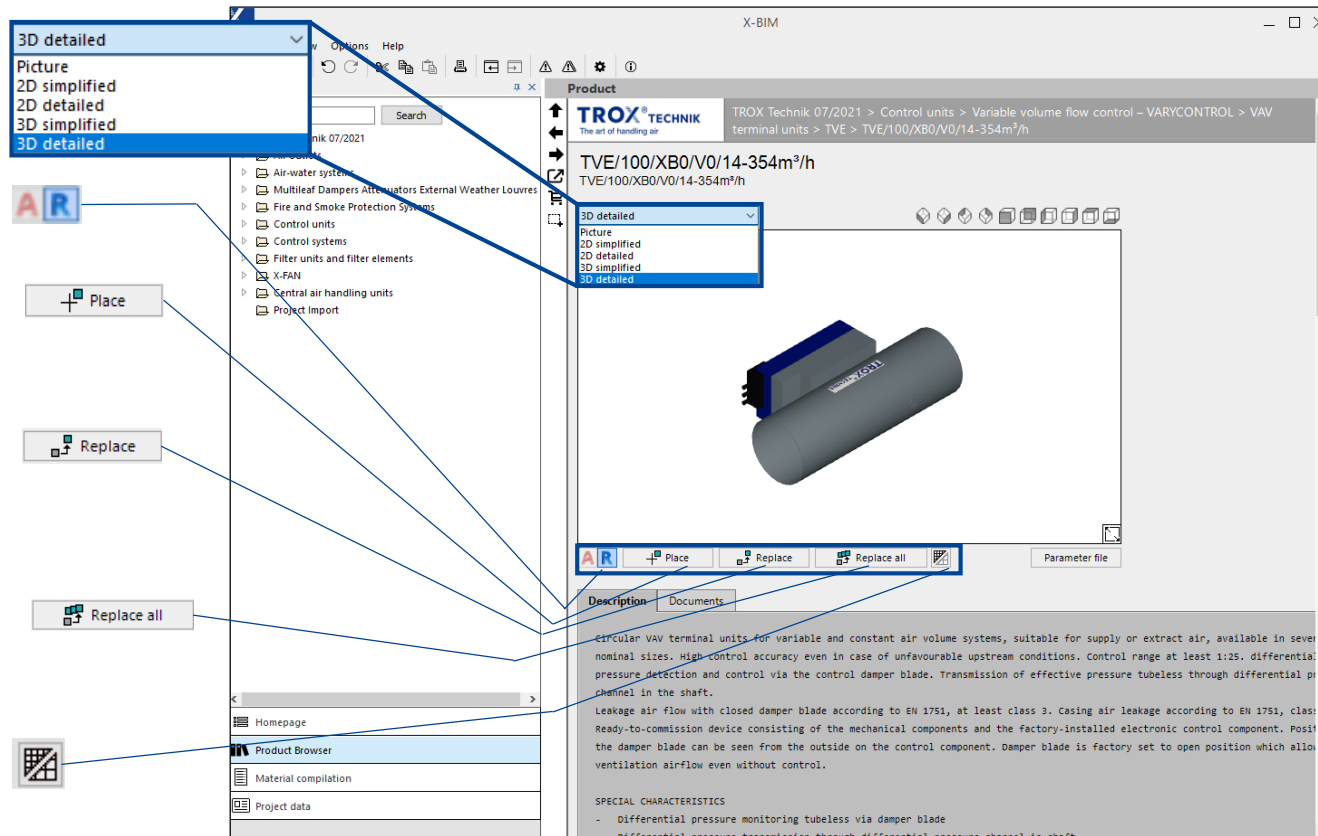

Strategies of use

1. Configure specific products on demand

- Selecting and configuring the single product variant with the X-BIM CAD Browser (embedded EPF)
- Adding the product to the 3D - planning

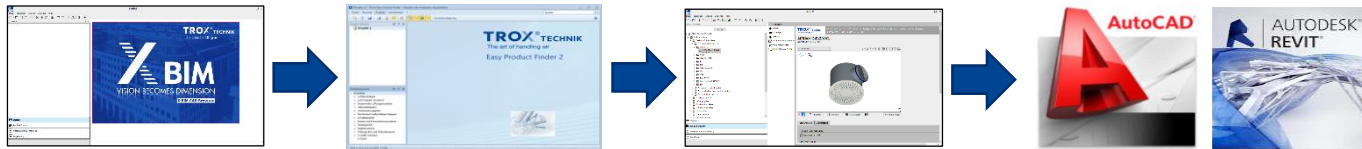

2. Importing a product or pre-configured X-BIM file from EPF Project or other TROX configurators

- Import of the product file or EPF project file (xml) into X-BIM CAD Browser
- Adding the products to the 3D - planning

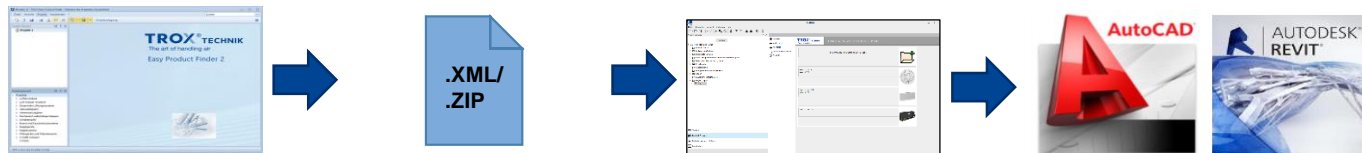



Configuring and importing TROX components

Page 17 - 22

TROX Components → Selection on Demand

X-BIM CAD Browser

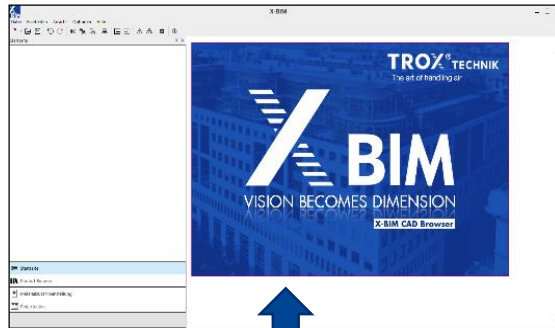

Embedded TROX EPF

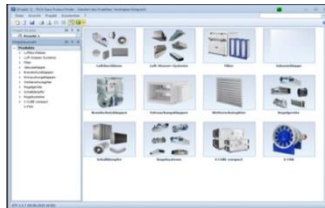

Alternatively generation of geometry data in DXF, DWG and IFC formats

Planning software based on Revit or AutoCAD

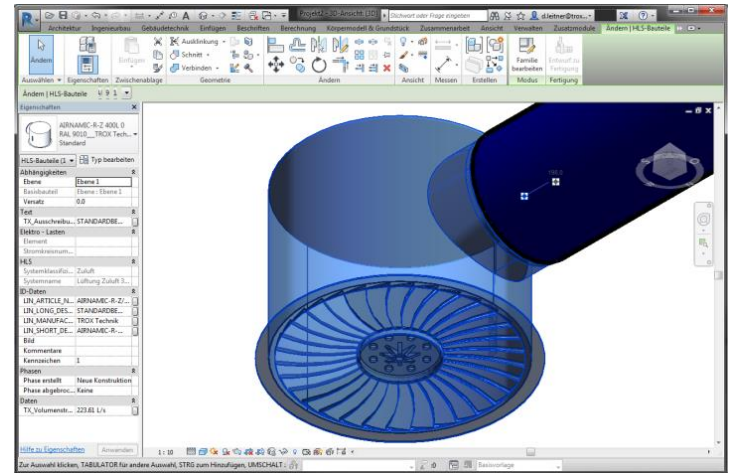

Selecting a product type

1

Use one of these three options to select a product

Direct search by entering product name

Select a product by its type and series name

Select a product by its picture

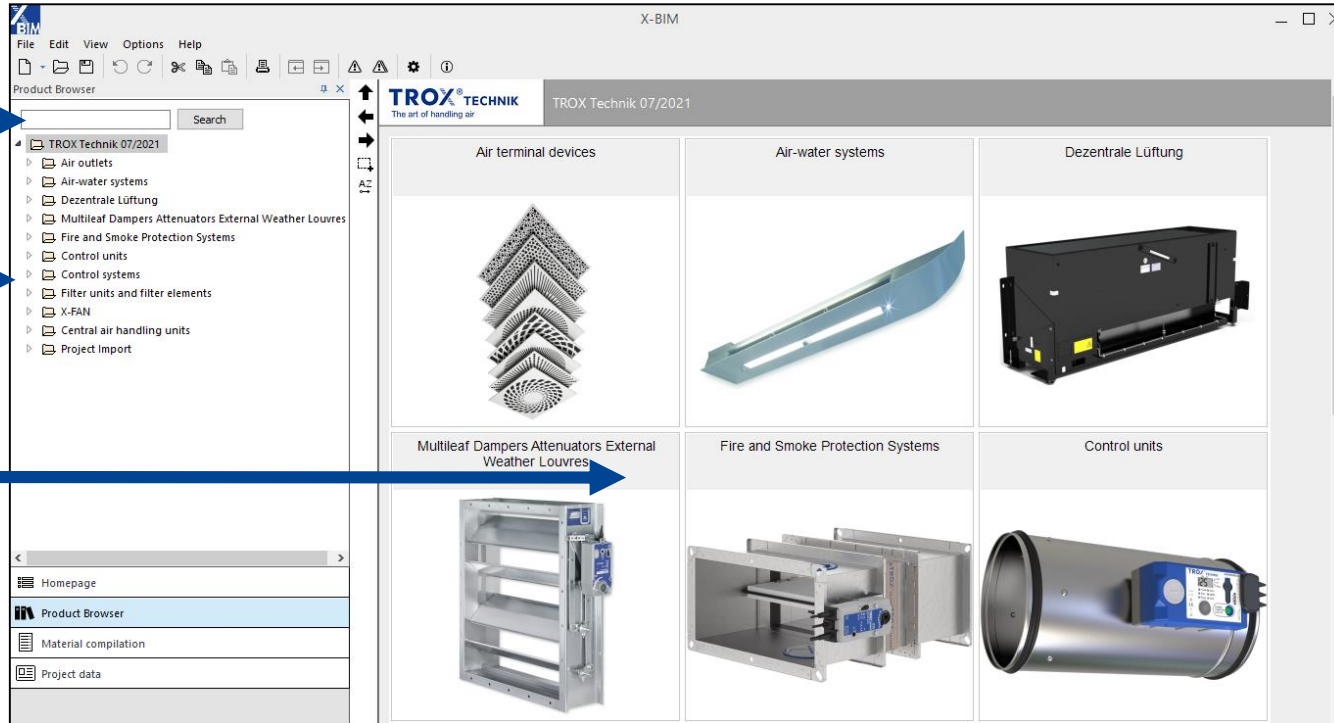

Selecting a product variant

2 Click on **Select product...** for opening the configuration context menu / product selection

The screenshot displays the X-BIM software interface. On the left, the 'Product Browser' window shows a hierarchical tree structure. The path is: TROX Technik 07/2021 > Air outlets > Ceiling diffusers > Ceiling swirl diffusers > AIRNAMIC. The 'AIRNAMIC' item is highlighted. Below this, a larger view of the tree shows the same path, with 'AIRNAMIC' selected. The main workspace on the right shows the breadcrumb path: TROX Technik 07/2021 > Air terminal devices > Ceiling diffusers > Ceiling swirl diffusers > AIRNAMIC. Below the breadcrumb, there is a 'Select product...' button and a circular diffuser image. A blue callout box with the number '2' and an arrow points to the 'Select product...' button. A text box next to the arrow contains the instruction: 'Click on Select product... for opening the configuration context menu / product selection'.

Configuring a variant using the Easy Product Finder

3 Configure the required variant using the TROX Easy Product Finder GUI (EPF version is embedded, no additional installation necessary)

4 Click → to transfer the selected variant back to the X-BIM CAD Browser*

Product list

- Products
 - Air Diffusers
 - Swirl diffusers
 - AIRNAMIC
 - VDW
 - FD
 - TDF
 - TDV
 - RFD
 - XARTO
 - TID
 - DCS
 - VD
 - VDL
 - WAVEDRALL WD HESCO

Input

Strategy: Single row diffuser arrangement

Volume flow

Volume flow q_v

Spacing/Distances

Distance a

Distance x

Distance h_1

Results

Spacing/Distances

Distance ($h_1 + x$) | 2,4 m

Aerodynamic results

Effective air velocity v_{eff} 4,08 m/s

Throw distance l_t 4,4 m

Velocity at h_1, v_{h_1} 0,34 m/s

Temperature difference at $h_1, \Delta t_{h_1}$ -0,78 K

Velocity at l, v_l 0,41 m/s

Sound power level/Pressure drop

	Δp_{pt}	Lw A	63 Hz
damper blade position open	34	36	36
damper blade position 45°	79	43	37
damper blade position closed	140	52	39

*You can only transfer variants with existing geometry data in the embedded TROX Easy Product Finder.

Transferring data to a project

5 Click on **Place** to transfer the product variant to your current Revit or AutoCAD project

6 Use the specific product model for your project. Connections, order code, specification text and technical data* are also transferred to Revit.

Eigenschaften	
AIRNAMIC-R-Z 400L 0 RAL 9010__TROX Technik__AIRNAMIC-R-Z 400L 0 RAL 9010 __109F__ Standard	
HLS-Bauteile (1) Typ bearbeiten	
Abhängigkeiten	
Ebene	Ebene 1
Basissbauteil	Ebene: Ebene 1
Versatz	0,0
Text	
TX_Ausschreibungstext	STANDARDBESCHREIBUNG...
Elektro - Lasten	
Element	
Stromkreisnummer	
HLS	
Systemklassifizierung	Nicht definiert
Systemname	
ID-Daten	
LN_ARTICLE_NUMBER	AIRNAMIC-R-Z400L/0/RAL 9010
LN_LONG_DESCRIPTION	STANDARDBESCHREIBUNG...
LN_MANUFACTURER	TROX Technik
LN_SHORT_DESCRIPTION	AIRNAMIC-R-Z400L/0/RAL 9...
Bild	
Kommentare	
Kennzeichen	1
Phasen	
Phase erstellt	Neue Konstruktion
Phase abgebrochen	Keine
Daten	
TX_Volumenstrom	223.61 L/s

*Transferred data amount depends on the product series.



EPF projects as a basis for BIM data

Page 23 -28

Use EPF project as basis for BIM data

EPF project

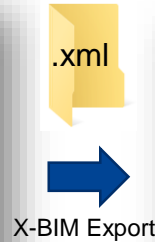
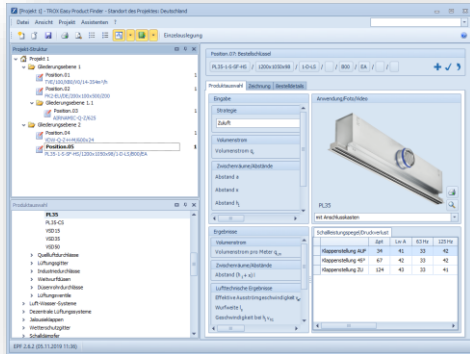

Project imported into
X-BIM CAD Browser

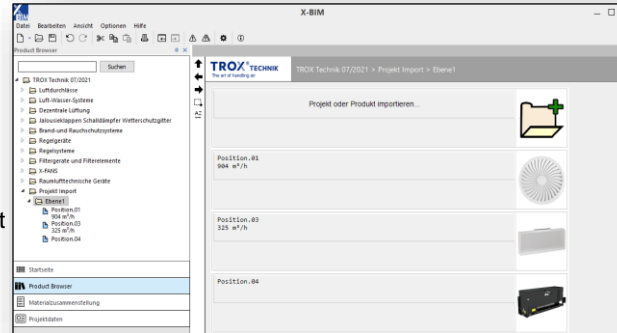

Design software based
on Revit or AutoCAD

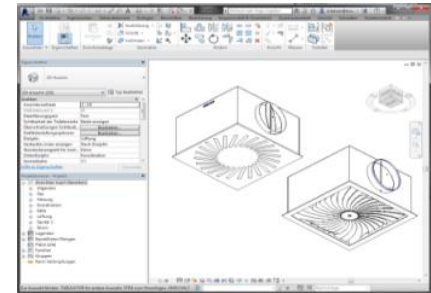

Importing EPF projects into the X-BIM CAD Browser makes it easy to use the product data of products which are pre-configured in an EPF project already or to create product compilation faster than one by one in the X-BIM CAD Browser.

Project overview in the Easy Product Finder

1 Create EPF project

Add configured products to the project with the **+** button.

2

The screenshot shows the TROX Easy Product Finder software interface. A context menu is open over a product list, with 'X-BIM Export ...' selected. A blue arrow points from the '1' callout to this menu. Another blue arrow points from the '2' callout to a '+' button in the top right of the product details panel. The main window shows a project tree on the left, a product list in the center, and a detailed view of a selected 'TVE250 XBO' product on the right, including input parameters, operating values, and a table of specifications.

Order code	Control range min. volume flow [m³/h]	Control range max. volume flow [m³/h]	Volume flow q v [m³/h]	Air-regenerated noise L _{W,A} [dB(A)]	Ca
TVE/160/NB0/V0/35-929m³/h	(35.. 929)	(35.. 929)	929	64	64
TVE/200/NB0/V0/55-1513m³/h	(55.. 1.513)	(55.. 1.513)	1.513	66	66
TVE/250/NB0/V0/87-2293m³/h	(87.. 2.293)	(87.. 2.293)	2.293	67	67

Exporting and saving the X-BIM project file from EPF

3 Export X-BIM file by selecting in the "File"- menu

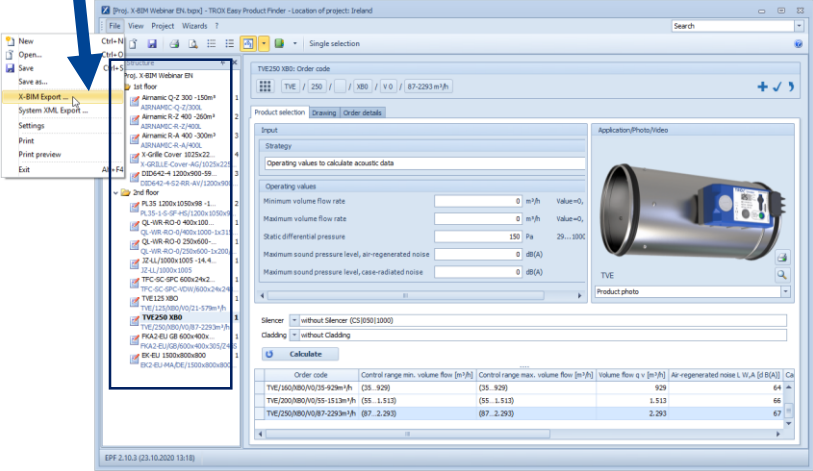

4 Save X-BIM file (.xml) on your computer

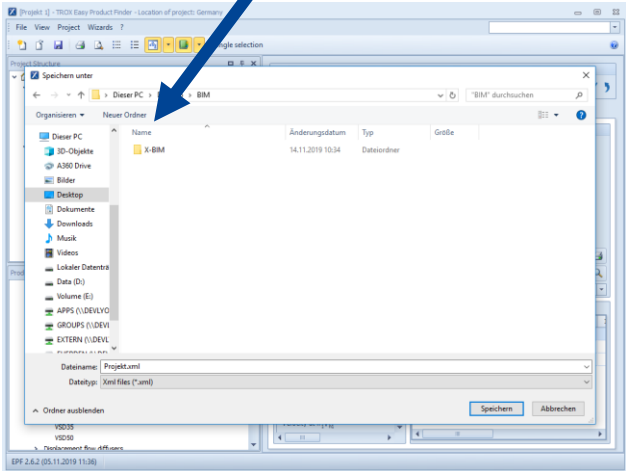

Importing the X-BIM project file into the X-BIM CAD browser

6 Choose **Import project or product...** to open the dialog box for selecting the project file and select the saved XML-file which has been saved before (see step 4)

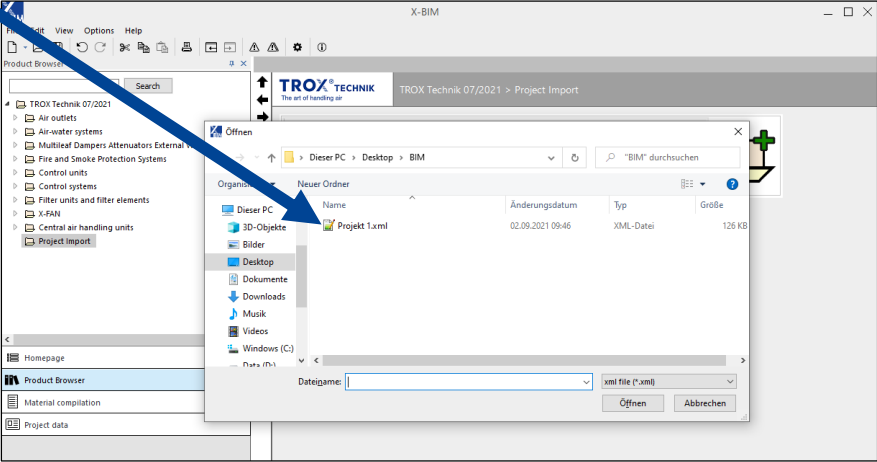
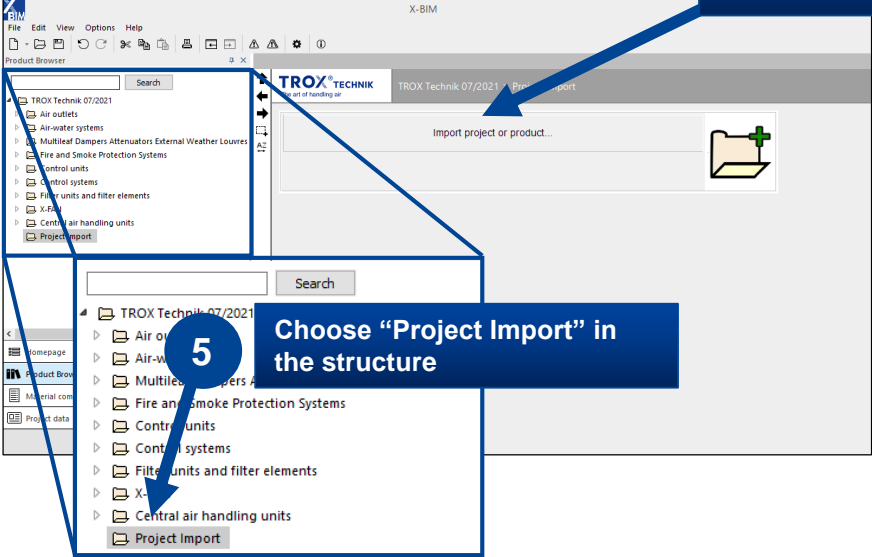

Overview of the project structure in the X-BIM CAD Browser

Products and project structure are displayed in the browser.

7 Choose any listed product to transfer it into the Revit/AutoCAD application

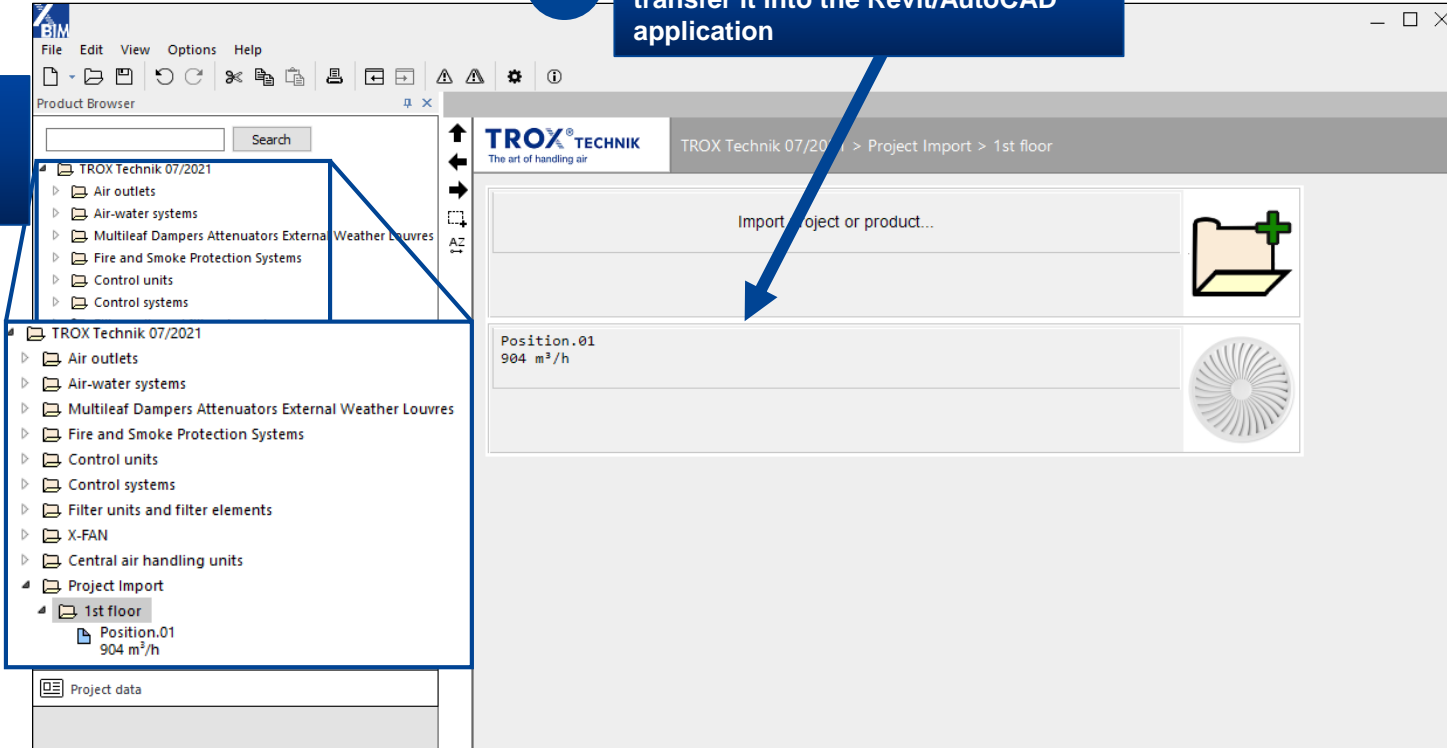



Configure and import TROX air handling units

Page 29 - 41

Principle of creating and integrating an X-BIM file for TROX air handling units

X-CUBE air handling units

X-CUBE Project file

X-BIM CAD Browser

Design software based on Revit or AutoCAD

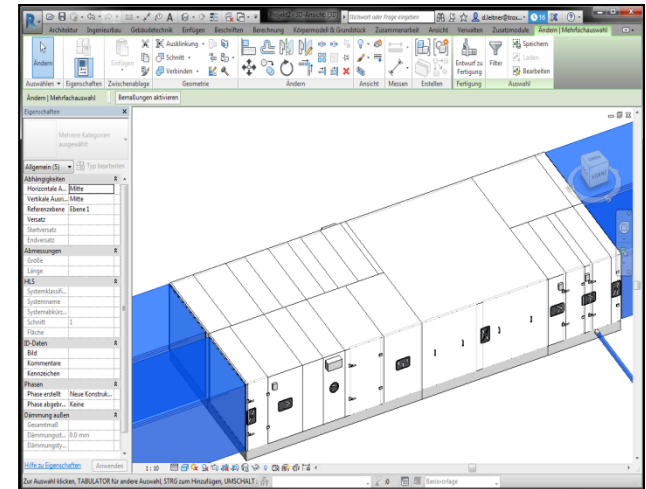
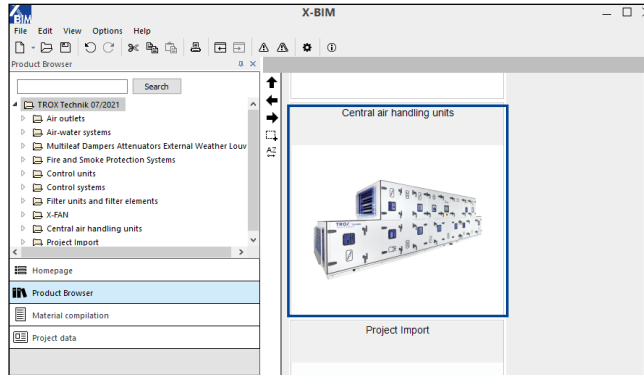
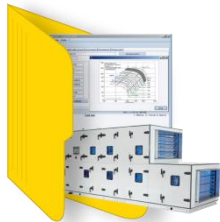

Data basis for air handling units

X-CUBE air handling units

Option 1

AHU online configurator

AHU can be configured online



Option 2

TROX AHU sales

AHU is configured by TROX AHU sales

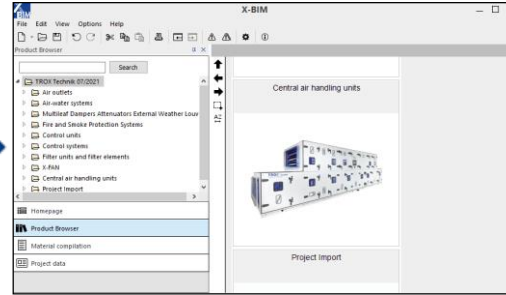

Design software based on Revit or AutoCAD

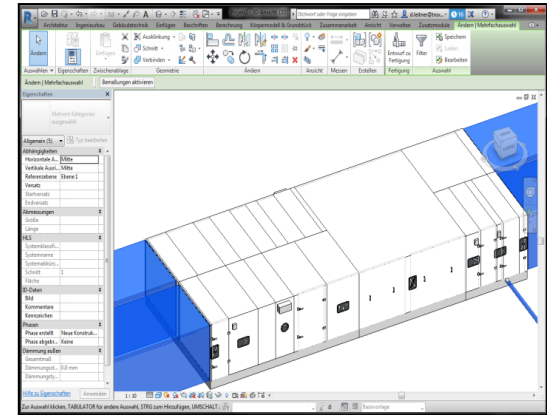

Alternatively generation of geometry data in DXF, DWG and IFC formats

AHU online configurator

1 TROX Homepage: Choose myTROX and select the menu Design

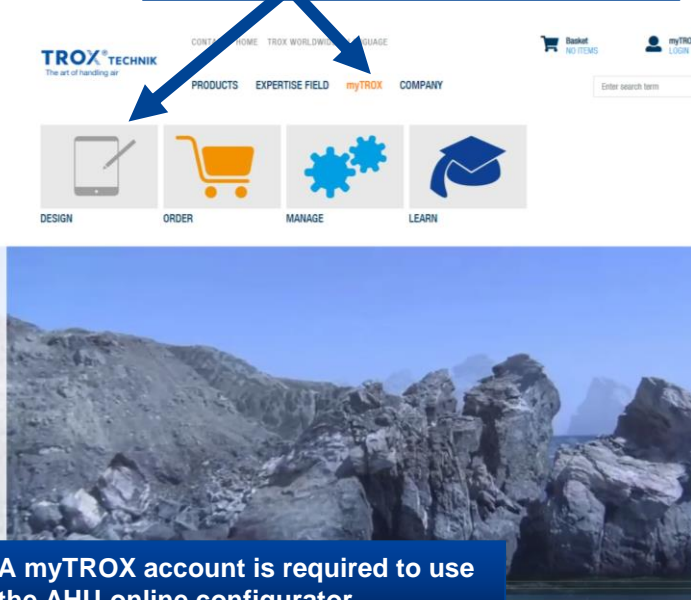

A myTROX account is required to use the AHU online configurator.

2 Choose AHU online configurator.

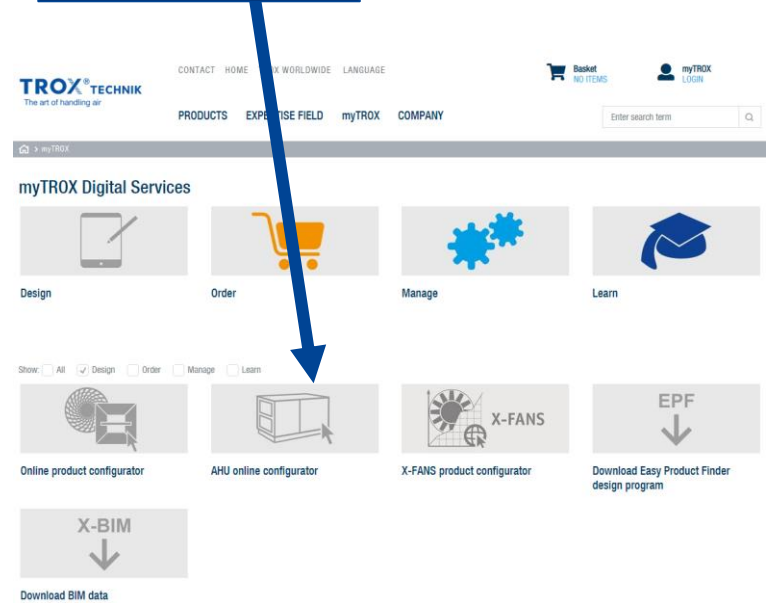

AHU online configurator

3

After login to the myTROX account, start a new project → [NEW PROJECT](#) >

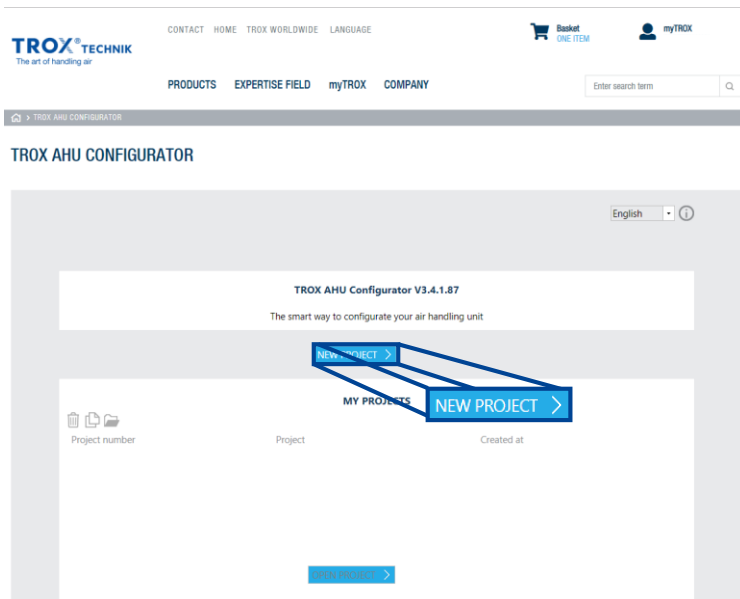

4

Select the desired X-Cube variant, assign position name and start configuration.

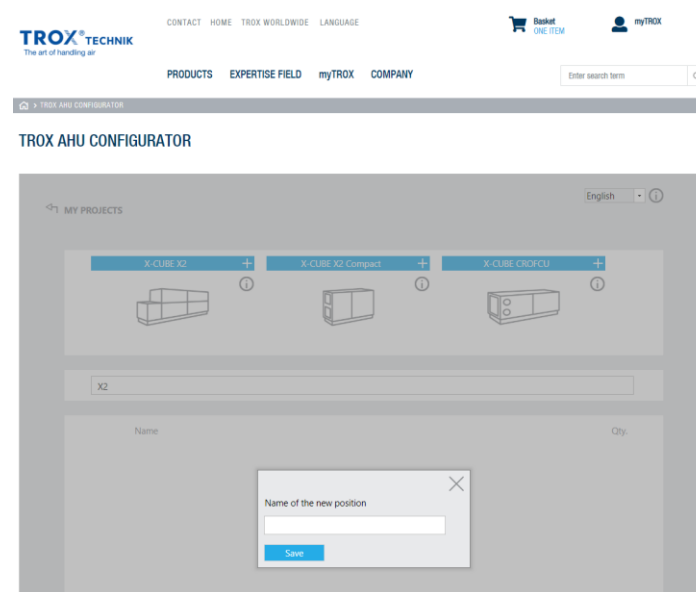

AHU online configurator

5

Go through the menu and adjust the default values acc. to your requirements.

The screenshot displays the TROX AHU online configurator interface. On the left, a dark sidebar menu lists various configuration categories: Requirements, Type of unit, Operating point, Connection, Filtering, Heating, Cooling, Attenuation, Humidification, Fan, and Calculation. The 'Requirements' category is highlighted. The main content area shows the 'TROX AHU CONFIGURATOR' title and a list of requirements with checkboxes and radio buttons. The 'Requirements' section is expanded, showing three categories: Efficiency class, Maintenance, and Casing quality. Each category has a 'Standard' option (radio button) and a 'Premium features' option (checkbox). The 'Premium features' options are checked. The interface also includes a search bar, a language dropdown set to 'English', and a 'Cancel' button.

Category	Standard	Premium features
Efficiency class	<input type="radio"/>	<input checked="" type="checkbox"/>
Maintenance	<input type="radio"/>	<input checked="" type="checkbox"/>
Casing quality	<input type="radio"/>	<input checked="" type="checkbox"/>

6

Start calculation to create your specific product information.

AHU online configurator

After the calculation, several files can be downloaded, including the BIM data for the TROX X-BIM CAD BROWSER.

The screenshot shows the TROX AHU configurator interface. At the top, there is a navigation bar with links for CONTACT, HOME, TROX WORLDWIDE, and LANGUAGE. Below this is a search bar and a user profile icon labeled 'myTROX'. The main content area is titled 'TROX AHU CONFIGURATOR' and contains a form with fields for 'Pos.-no.' (value: 1) and 'Name'. Below the form is a 'Documents' section with tabs for 'Overview' and 'LCC Calculation'. A list of download options is shown at the bottom, including 'Data sheet', 'Drawing', 'Specification text', 'BIM data for the TROX X-BIM CAD Browser', and 'Full package'. The 'BIM data for the TROX X-BIM CAD Browser' option is highlighted with an orange box, and its download icon is also highlighted with an orange box. A blue arrow points from a callout box to this download icon.

7

Download X-BIM CAD Browser file
(xml data format)

Get X-BIM file from TROX X-CUBE Sales Team

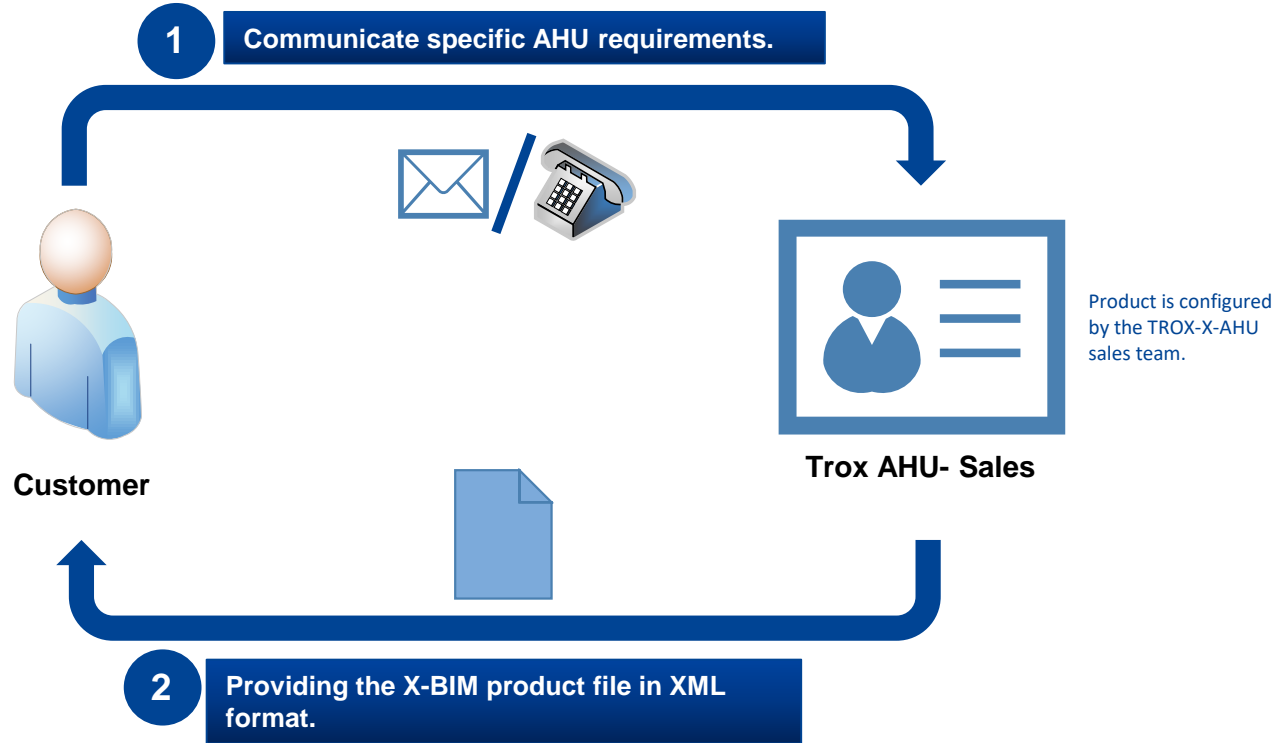

Importing AHU X-BIM file into X-BIM CAD Browser

1

Select X-CUBE category in the X-BIM CAD Browser product browser structure

2

Click on **Import AHU...** to open the dialogue for selecting the project-specific X-CUBE xml or zip file

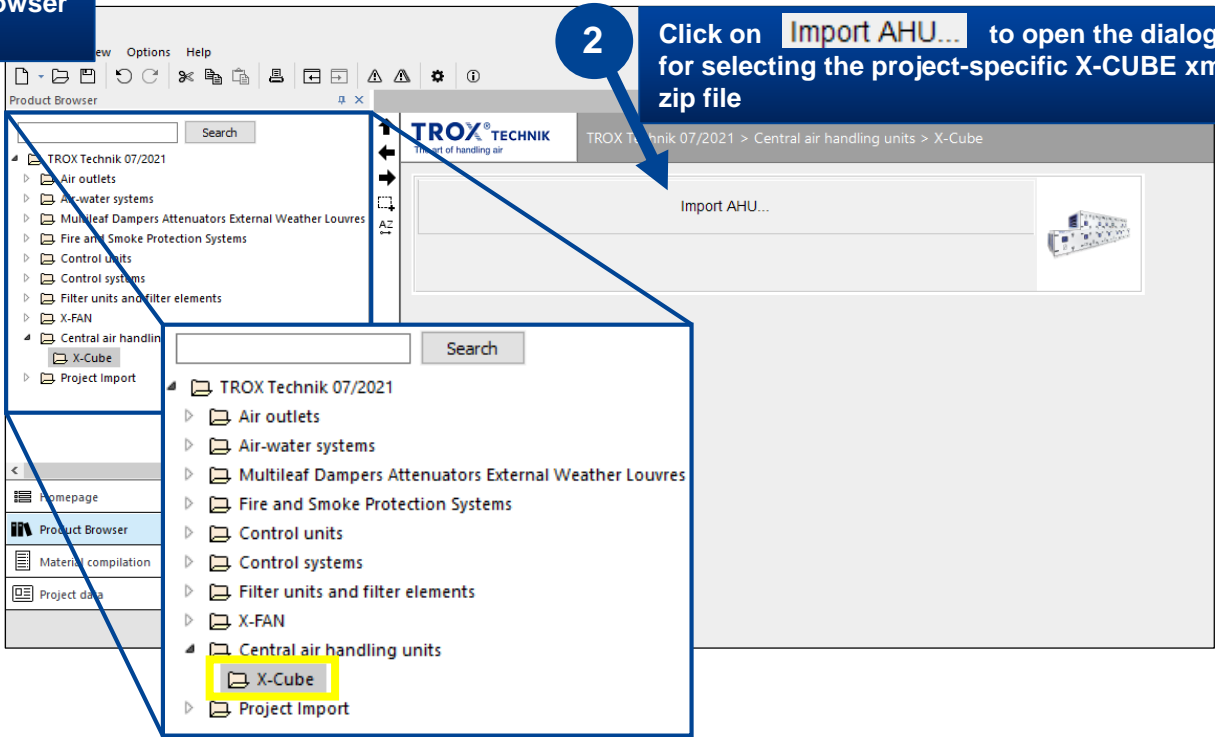

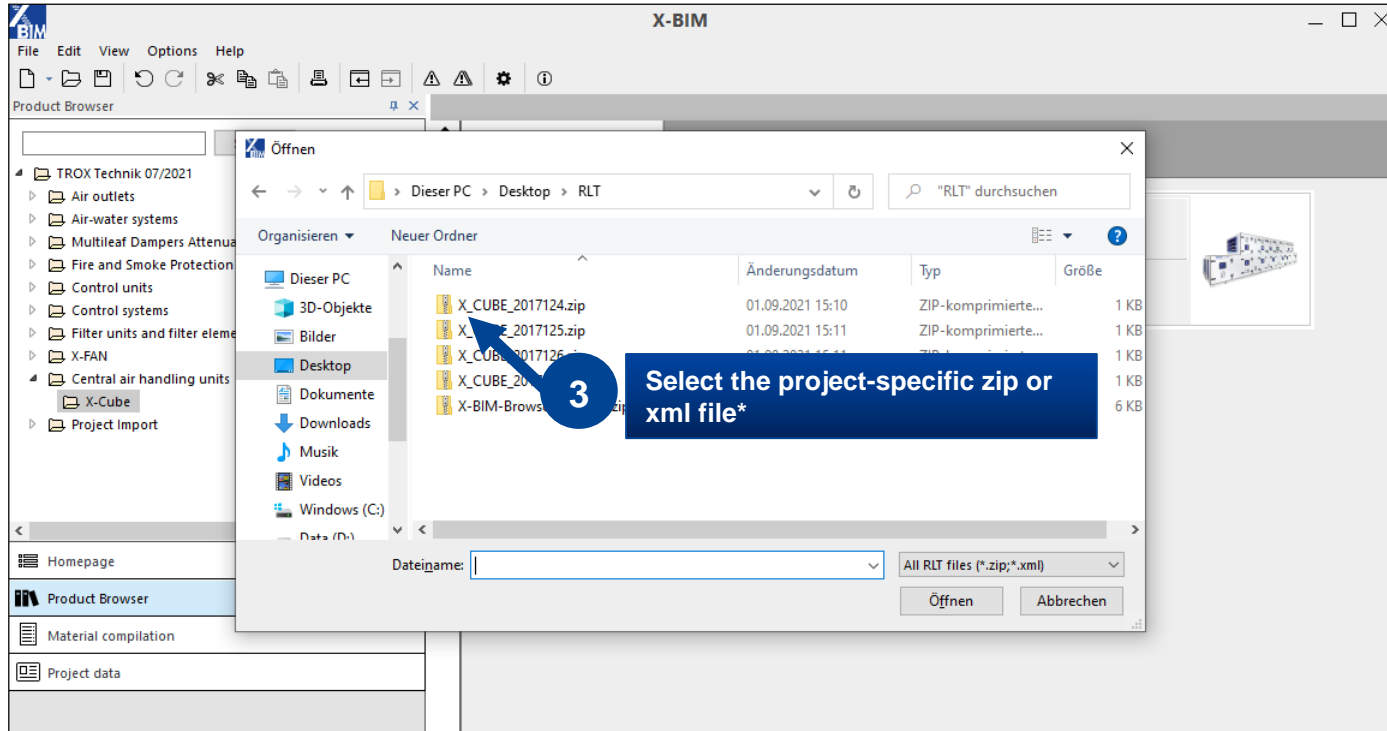

*Ask your TROX sales representative for the project-specific X-BIM file or generate xml with the AHU online configurator.

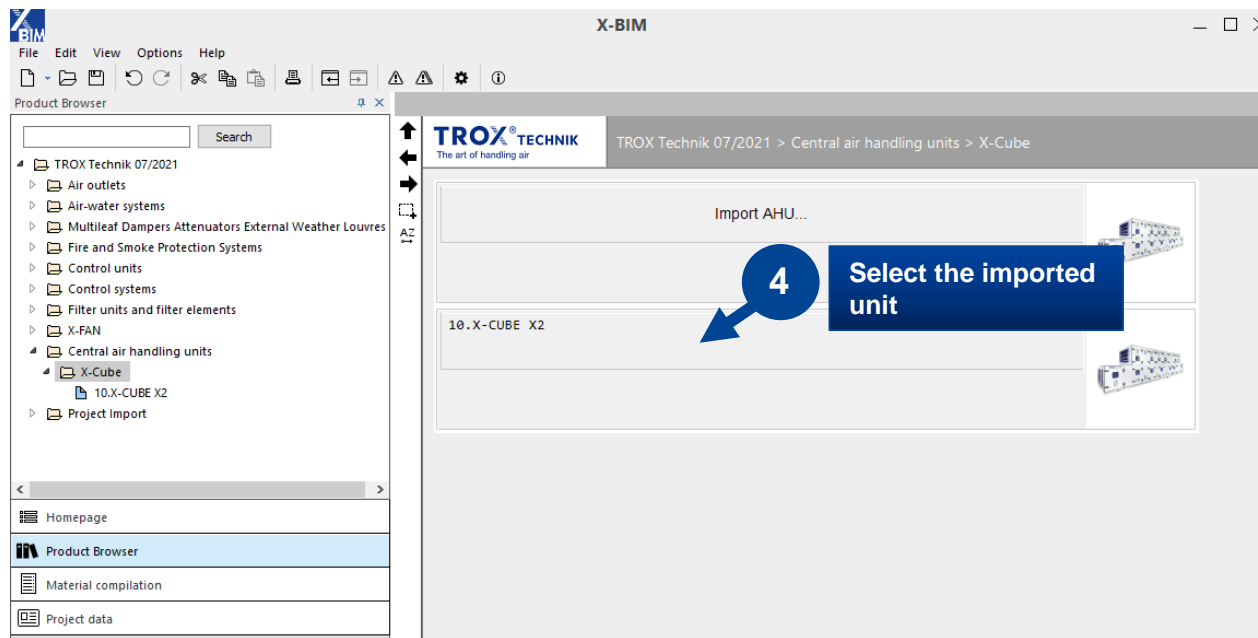

Transferring data to a project

Click **Place** to transfer the selected X-CUBE air handling unit to your running Revit or AutoCAD project

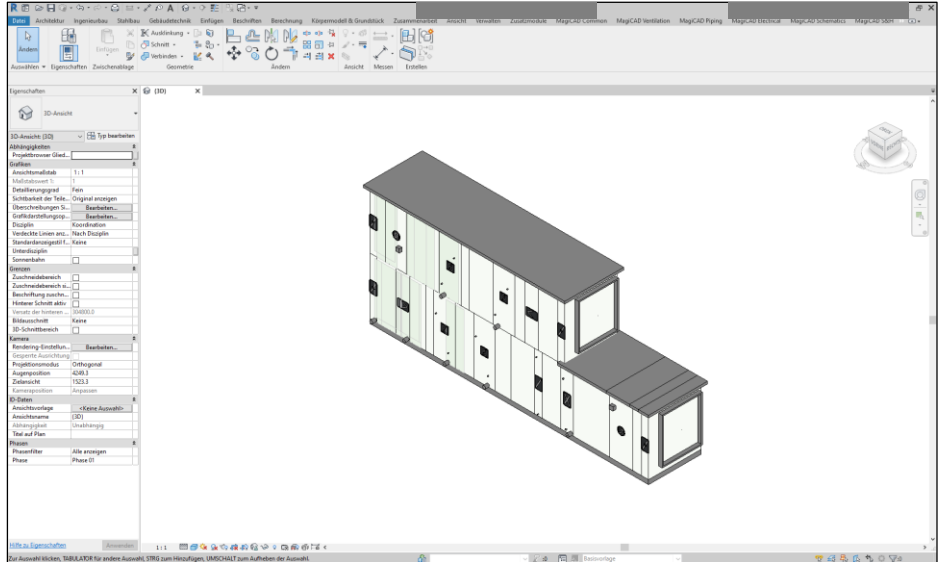
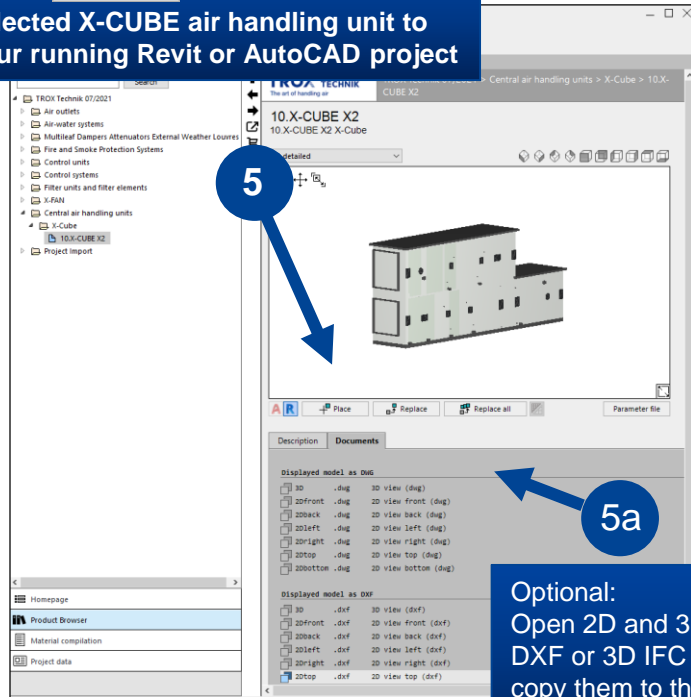

Optional:
Open 2D and 3D DWG,
DXF or 3D IFC files or
copy them to the
clipboard *

Technical data and additional attributes

The screenshot displays the Revit software interface with a 3D model of a TROX X-CUBE air handling unit. A blue callout box labeled "Geometry and connections" points to the 3D model. Another blue callout box labeled "Technical data and additional attributes" points to a properties table. The table lists various parameters and their values, categorized into ID-Data, Bauelement, and Daten.

Typenparameter	Parameter	Wert
ID-Daten		
Elektronik	TX_erp_unt_type	NWLA ZLA
Elektronik	TX_fan_drive	variable speed drive
Elektronik	TX_filter_ETA_3_order_code_1	MFI+PM10-50%-PLA / 592x592x292 x 6
Elektronik	TX_filter_ODA_1_order_code_1	MFI+PM1-65%-PLA / 592x592x292 x 6
Elektronik	TX_manufacturer	TROX GmbH
Elektronik	TX_model	X-CUBE
Elektronik	Typenbild	
Elektronik	Bauelement	
Elektronik	Modell	10.X-CUBE X2 X-Cube
Elektronik	Hersteller	TROX Technik (DEU)
Elektronik	Typenkommentare	
Elektronik	URL	
Elektronik	Beschreibung	
Elektronik	Baugruppenkennzeichen	
Elektronik	Kosten	
Elektronik	Baugruppenbeschreibung	
Elektronik	Typenmarkierung	
Elektronik	OmniClass-Nummer	23.75.00.00
Elektronik	OmniClass-Titel	Climate Control (HVAC)
Elektronik	Codename	
Daten		
Elektronik	TX_air_exhaust_velocity	1.00 m/s
Elektronik	TX_air_exhaust_volume_flow	7000.0000 m³/h
Elektronik	TX_air_supply_duct_pressure_drop	400.00 Pa
Elektronik	TX_air_supply_velocity	1.00 m/s
Elektronik	TX_air_supply_volume_flow	7000.0000 m³/h
Elektronik	TX_casing_radiated_noise_LwA	65.000000
Elektronik	TX_cooler_SUP_capacity	38730.00 W
Elektronik	TX_cooler_SUP_fluid	Wasser
Elektronik	TX_cooler_SUP_fluid_pressure_drop	42900.00 Pa
Elektronik	TX_cooler_SUP_fluid_temperature_in	16.00 °C
Elektronik	TX_cooler_SUP_fluid_temperature_out	12.00 °C
Elektronik	TX_cooler_SUP_fluid_volume_flow	5.5357 m³/h
Elektronik	TX_erp_thermal_efficiency	71.8000%
Elektronik	TX_exhaust_dfp_int	320.800000
Elektronik	TX_external_leakage	1.6160%



Configure and import TROX X-FAN devices

Page 42 - 49

X-FANS

X-FAN project file



X-BIM CAD Browser

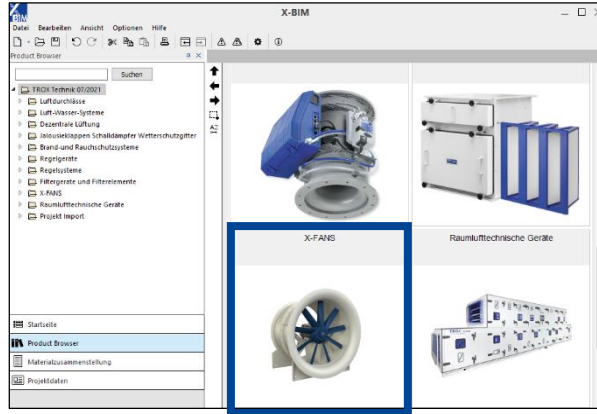

Planning software based on
Revit or AutoCAD

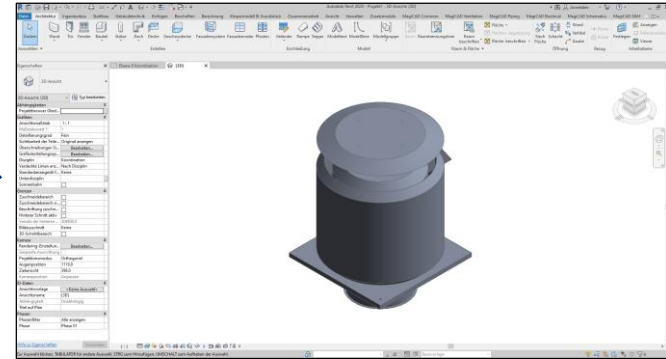

Get X-BIM file from TROX X-FANS Sales Team

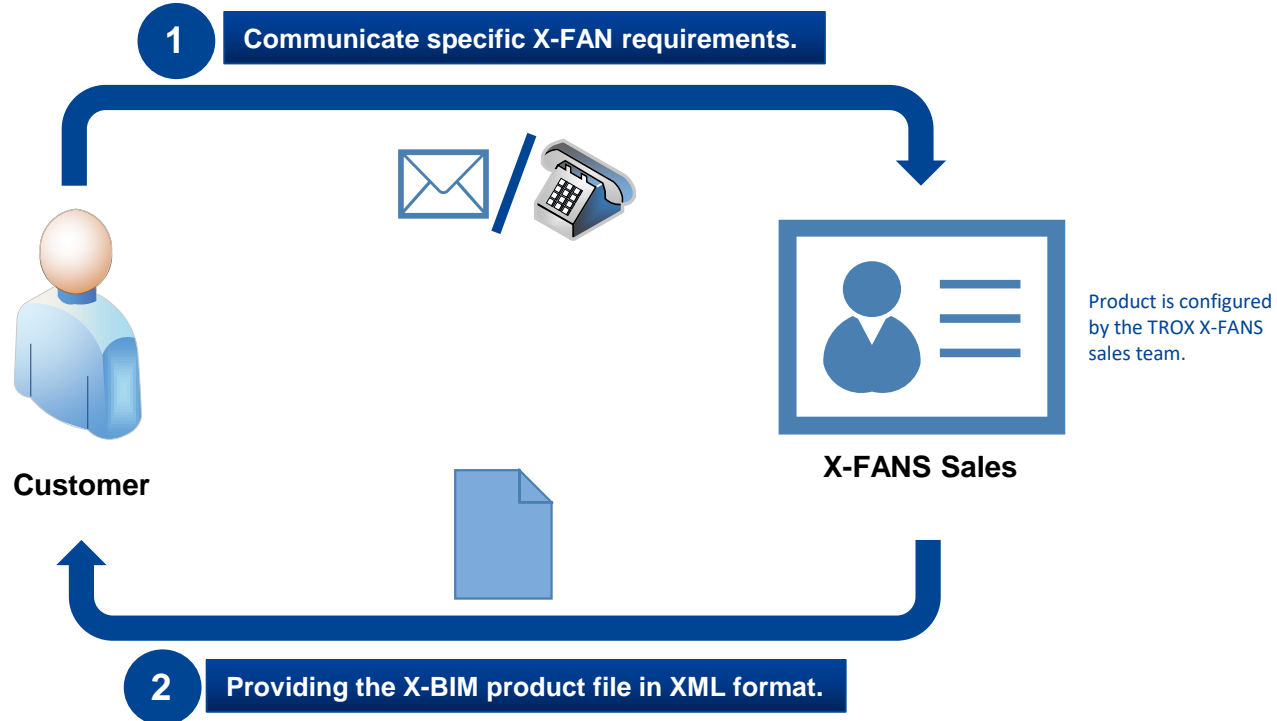

1

Select X-FAN in the product structure

2

Select **Import X-FAN...** to open the dialog box for selecting the X-FAN ZIP or XML file.

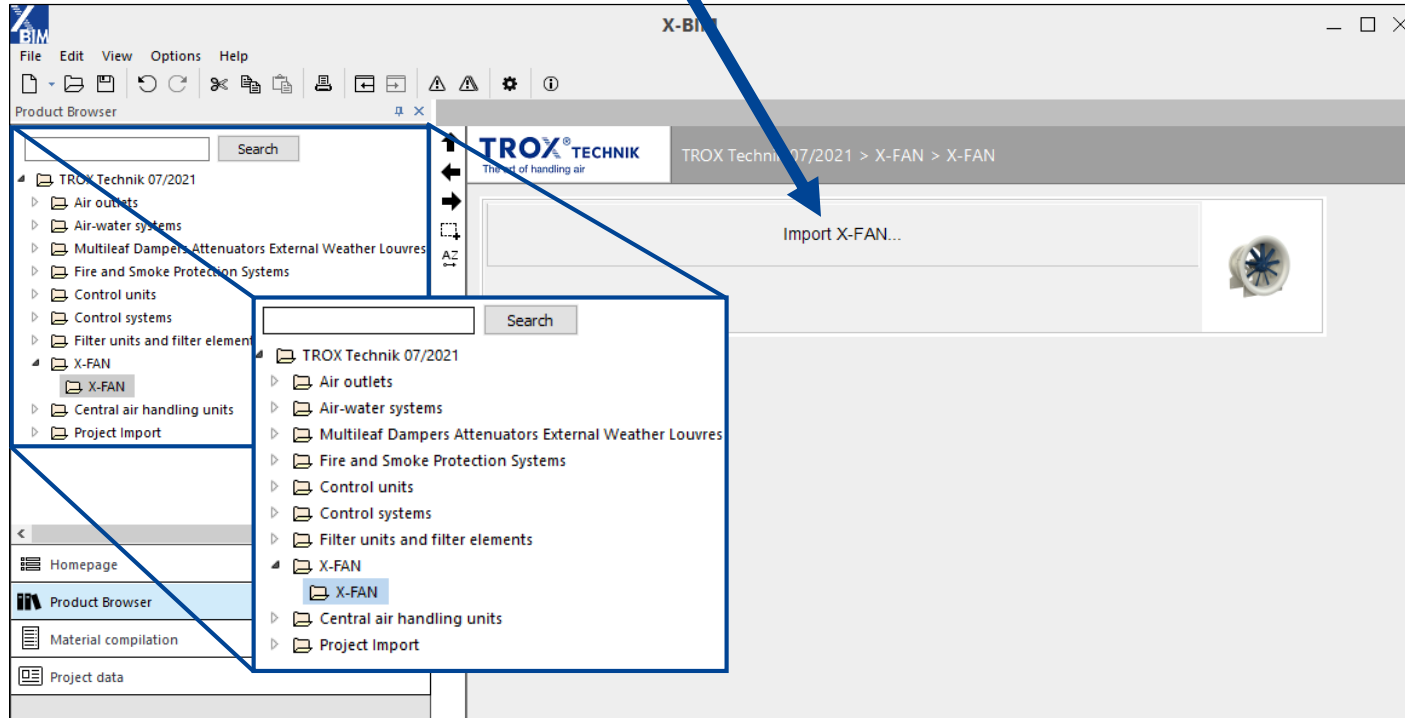

Loading an X-BIM file from an X-FAN device

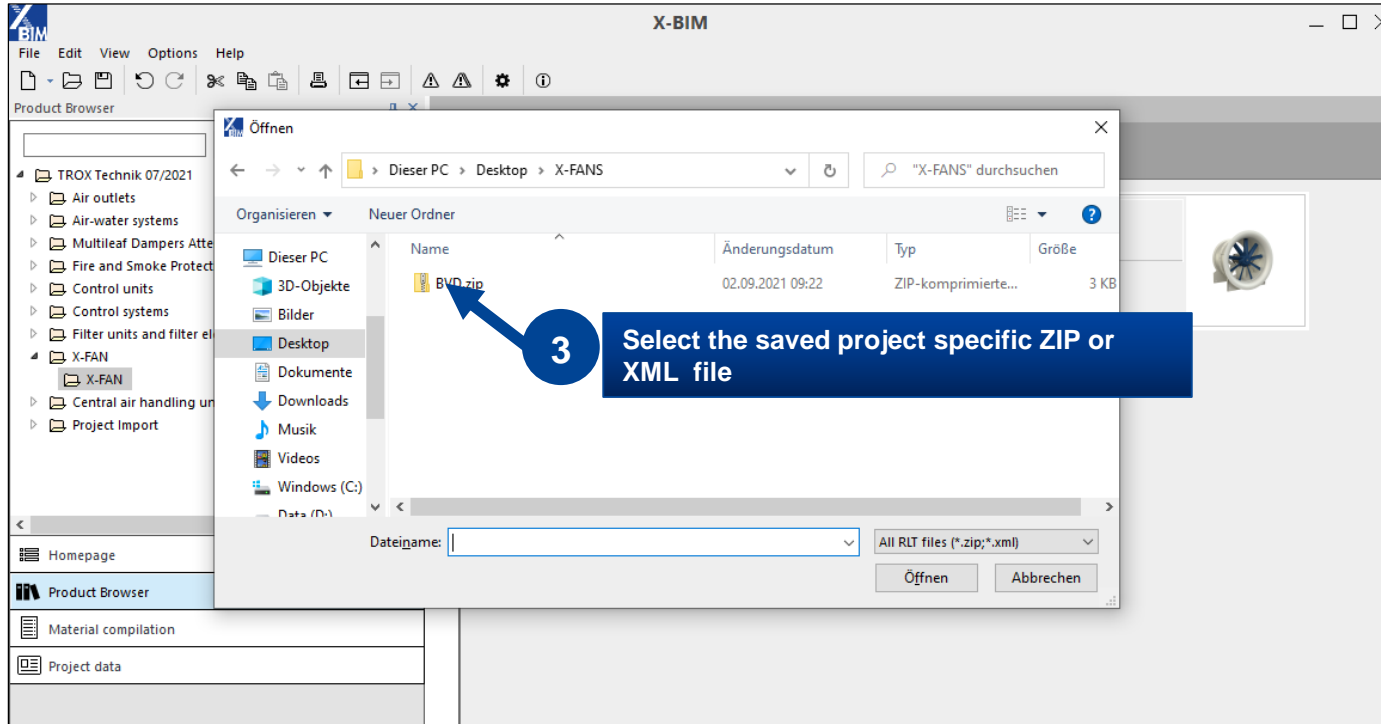

Selection of the imported device

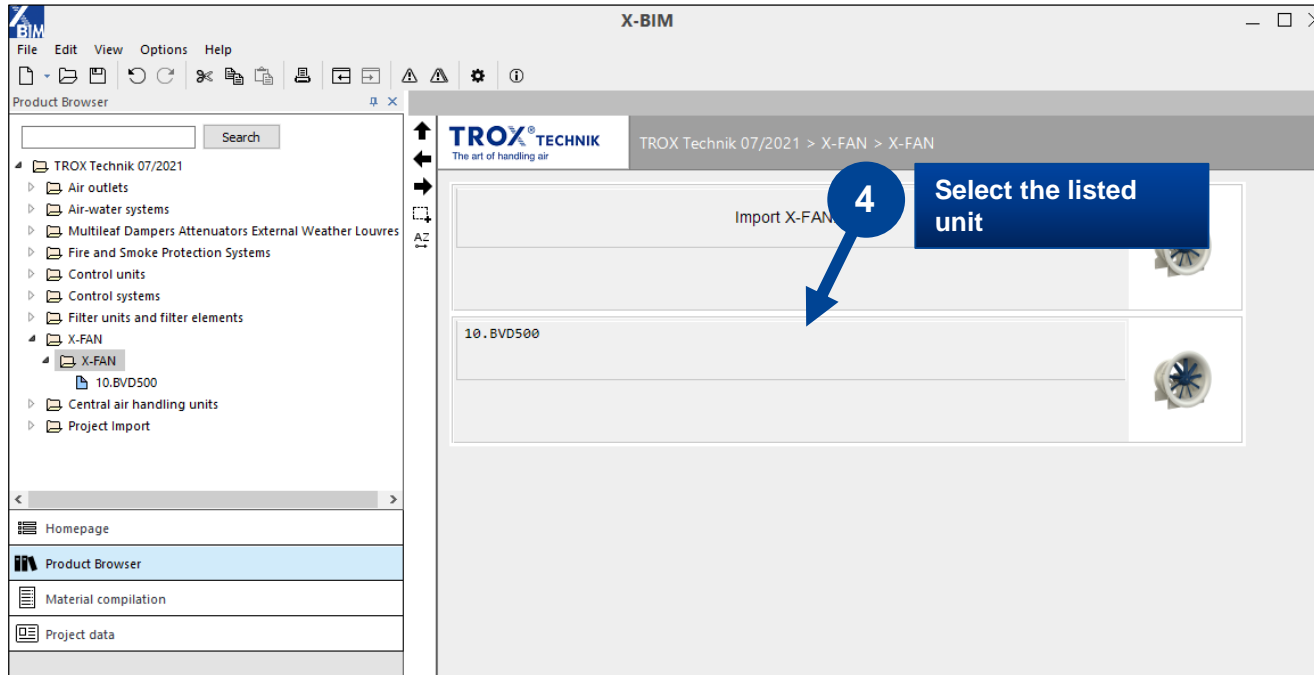

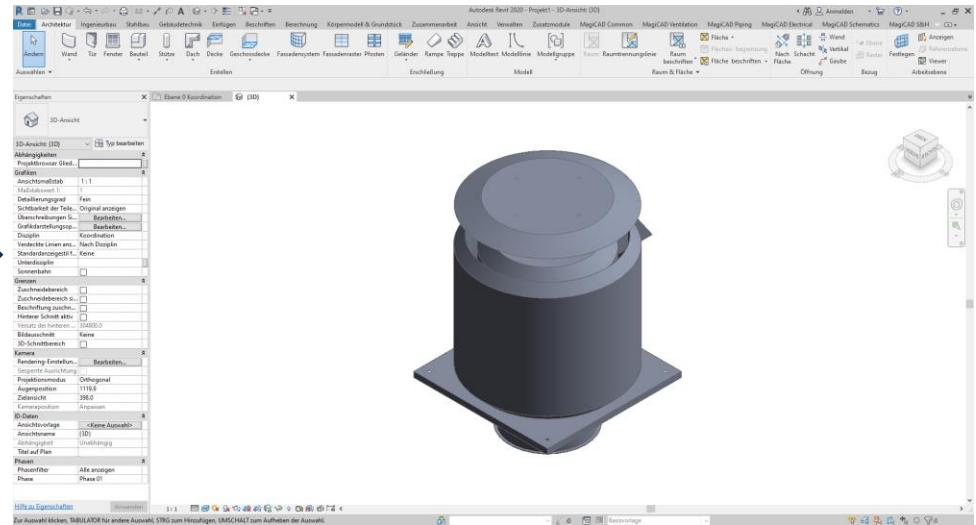
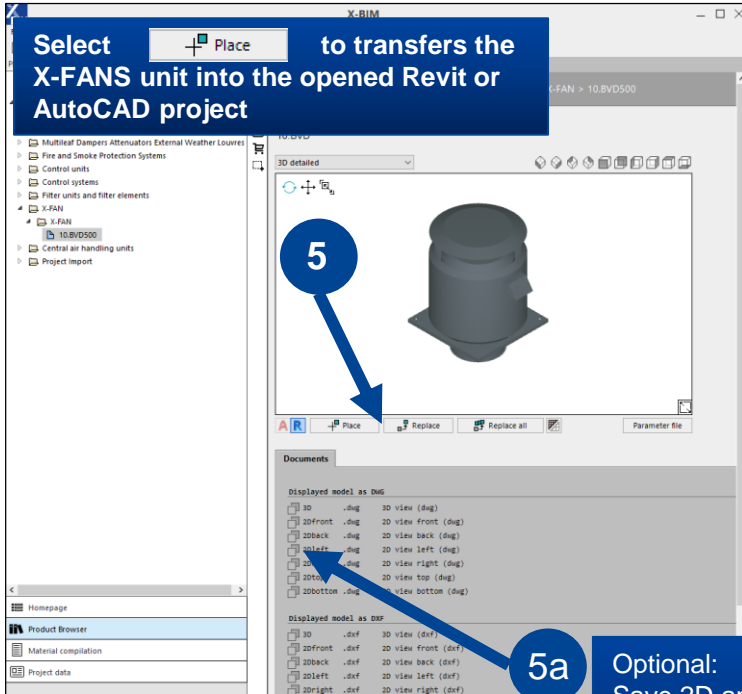

5a

Optional:
Save 2D and 3D DWG,
DXF or IFC files or send
them by E-Mail (copy to
clipboard)

Technical data and additional attributes

The screenshot displays the Autodesk Revit 2020 interface. On the left, the 'Properties' window is open for a 'TROX Technik (NT) #qv3tesj#'. The 'Mechanical Parameters' section is expanded, showing a table of technical data and additional attributes. A blue callout box points to this section with the text 'Technical data and additional attributes'. On the right, a 3D model of a cylindrical mechanical unit is shown in a semi-transparent blue view. A blue callout box points to the model with the text 'Geometry + connector'. The Revit ribbon at the top shows various toolsets including 'Architecture', 'Structure', 'Steel', 'Systems', 'Insert', 'Annotate', 'Analyze', 'Massing & Site', 'Collaborate', 'View', 'Manage', 'Add-Ins', 'MagiCAD Common', 'MagiCAD Ventilation', 'MagiCAD Piping', 'MagiCAD Electrical', 'MagiCAD Schematics', 'MagiCAD SBH', and 'Modify | Mechanical Equipment'. The 3D view shows a cylindrical unit with a square base and a top flange, with a blue callout box pointing to it with the text 'Geometry + connector'.

Parameter	Value
Mechanical	
Classification	None
Identity Data	
TX_manufacturer	TROX X-FANS GmbH
TX_model	BVD 300
Type Image	
Keynote	
Model	3555-10.BVD
Manufacturer	TROX Technik (NT)
Type Comments	
Description	
URL	
Assembly Code	
Cost	
Assembly Description	
Type Mark	
OmniClass Number	23.75.00.00
OmniClass Title	Climate Control (HVAC)
Code Name	
Data	
TX_LwA_3deg (dB(A))	75.000000
TX_volumeflow1	2222.22 L/s
TX_acousticLevelOutput	79.000000
TX_aerodynamicEfficiency1	62.000000%
TX_applicationArea	-
TX_bladeAngel	30.00°
TX_designTemperature	20.00 °C
TX_externalPressureDrop1	326.00 Pa
TX_fanSpeed1	949.000000
TX_overallEfficiency	51.1583%
TX_powerConsumption	1290.20 W
TX_powerInputEngine	1.550694
TX_powerRequiredAtShaft1	1390.00 W
TX_staticEfficiency1	61.000000%
TX_type	Dachventilator mit Entrauchungsfunktion
TX_opt1	357.00 Pa



Further information

Page 50 - 51

X-BIM CAD Browser is based on a CAD browser by liNear GmbH. For more details of the software please refer to the manual. Please note that we have adjusted some of the CAD browser functions. That's why the liNear manual descriptions may differ from the actual version.

